

# ST-IIIB user manual





## Brief

Dear customer:

Congratulations on purchasing your new security system. Thank you for the confidence you have shown in us. You have chosen a high-quality

product that has been produced, tested, and packed with the greatest care. Please familiarize yourself with these instructions before attempting operation. It will only be sure if it is fitted properly. We hope your new security system will bring you lasting pleasure.

# Content

Chapter I Introduction	1
Chapter 2 Installation and Connection	4
2.1 Installation	4
2.2 Connection(N.O. N.C)	4
2.3 Install wired detector	4
2.4 Intall wereless detector	5
Chapter 3 Keybad and Operation	5
3.1 About panel	5
3.2 Basic operation	7
3.3 Flashes when phone line cut	7
3.4 Host arm and disarm	8
3.5 Alarm procedure	10
Chapter IV Voice alarm receiving and GSM control	11
4.1 Remote phone control	11
4.2 Alarm receiving phone operation	11
4.3 GSM remote operation	12
4.4 GSM alarm receiving	12
4.5 GSM control via SMS	12
Chapter IV Voice alarm receiving and GSM control	13
5.1 Set system clock	13
5.2 Set user password	13
5.3 Set voice phone	13
Chapter VI System Setting	14
6.1 Set password	14
6.2 Set CMS number	15
6.3 Set voice phone	16
6.4 Set system options	17
6.4.1 Set system clock	17

6.4.2 Set entry delay	18
6.4.3 Set exit delay	18
6.4.4 Set siren time	18
6.4.5 Set ring times	18
6.4.6 Set detector loss inspection	19
6.4.7 Set arm/disarm tone	19
6.4.8 Set arm/disarm report	20
6.4.9 Set others	20
6.4.9.1 Set emergency alarm siren type	20
6.4.9.2 Ac off inspection time setting	21
6.4.9.3 Magnetic contact inspection	21
6.4.9.4 Check wireless detector tamper	21
6.4.9.5 Set force arm	21
6.4.9.6 Set telephone line disconnect remind	22
6.4.9.7 Set zone alarm times	22
6.4.9.8 Set listen-in time	22
6.4.9.9 Set AC off remind	23
6.5 Manage wireless device	23
6.5.1 Set remote control	23
6.5.1.1 Enroll remote control	23
6.5.1.2 Enter remote control code	24
6.5.1.3 Delete remote control	24
6.5.2 Set detector	24
6.5.2.1 Detector coding	24
6.5.2.2 Enter detector code	25
6.5.2.3 Delete detector	25
6.5.3 Set appliance switch	25
6.5.3.1 Enroll appliance switch	25
6.5.3.2 Delete appliance switch	26
6.5.4 Enroll wireless siren	26
6.5.4.1 Enroll wireless siren	26
6.5.4.2 Delete wireless siren	26
6.6.5 Set door bell	27
6.5.5.1 Enroll doorbell	27
6.5.5.2 Delete doorbell	27

6.6.1 Set zone attribution	28
6.6.2 Set zone siren type	28
6.6.3 Set wired zone loop type	28
6.6.4 Set wired zone response speed	29
6.6.5 Set related zone	29
6.7 System maintance	30
6.7.1 Set timing operation	31
6.7.2 Recording	31
6.7.3 Play recording	31
6.7.4 Set programmable output port	31
6.7.5 Delete system events	32
6.7.6 Restore to factory default	32
6.8 Set GSM module	32
6.9 Advanced setting options	34
6.9.1 GPRS enable and disable	35
6.9.2 Set sever IP address	35
6.9.3 Set sever port	36
6.9.4 Set user ID	36
6.9.5 Set user password	36
6.9.6 GSM SMS language	36
6.9.7 Delay zone tone source options	37
6.9.8 Handshake tone input signal intensity	37
6.9.9 DTMF output signal intensity	37
6.9.10 Set LCD standby brightness	37
6.9.11 Alarm event retain time	38
Chapter VII technical specification	39
7.1 General data	39
7.2 Physical performance	39
Chapter VIII maintenance	40
8.1 Regular test	40
8.2 The cleanliness of control main machine	40
Chapter VX limitation of the products	40

# Chapter I Introduction

## 1.1 Function Introduction

- 1、 Alarm mode: with PSTN and GSM network alarm, GSM network with GPRS function(GPRS function is for China market only), remote arm and disarm panel through CMS or SMS CID protocol, SMS notification, the priority of PSTN and GSM network is Optional.
- 2、 With a new large-screen, full-touch buttons, LCD graphic display steps, work status, Alarm process easy and intuitive.
- 3、 The full English voice prompting operation: all local or remote operation, alarm information, event log view.
- 4、 GSM-hook and voice telephone with intercom function.
- 5、 All alarm information can be programmed for the following settings:  
0 does not send any information  
1, Send only SMS    2, Only call users    3, SMS + call user  
4, CMS only  
5, CMS + SMS.    6, CMS + call user    7. CMS + SMS + call user
- 6、 Sleep mode: Under sleep mode, all the lights, backlight, voice and remind tone are disabled.
- 7、 Alarm panel under idle status is equivalent to a cellphone, you can call through the GSM network for balance inquiries
- 8、 The associated zone: 4 groups associated zone, three kinds of association patterns, can effectively reduce false alarm or for other functions.
- 9、 PGM output: With a programmed output port, followed by five kinds of alarm events output.
- 10、 The doorbell Audio Optional:  
1. Ding Dong    2 Welcome    3. Recording    4. Dee-Dee~
- 11、 Remote phone operation: dialing by telephone offsite, after password verification, you can arm, disarm, listen-in premise, system status query and electrical switches controls and other operations.
- 12、 Voice Alarm: When panel alarm, it will automatically dial the preset user phone numbers to report alarm information then you can remote control the panel after enter user passwords.

- 13、 Wireless zones, each wireless zone can automatically learn the codes or be coded manually via the keyboard.
- 14、 8 wired zones, User can set the circuit type and speed of response, support N.O, N.C.
- 15、 Enable enroll total 8 wireless remote,8 electronic switch, 1 pc of wireless doorbell and Unlimited for quantity of one way wireless siren.
- 16、 Follow me phone #,two for CMS,four for private alarm receiving.
- 17、 Status inspection function:Enable record and inquiry 120 alarm event messages.Like the time when happens anti-tamper alarm,detector alarm, tel-line off,arm,disarm,system setting,battery low voltage etc.And also can inquiry the zone number and alarm type.
- 18、 Timing arm and disarm: 4 sets of timing arm and disarm time.
- 19、 Electrical switches control: User can remote switch on/off via phone or SMS, also can be controlled manually through the local alarm panel.
- 20、 Zone programmable: factory preset for each zone type. Users can modify all the zone type according to the actual needs .
- 21、 Clock: Built-in full automatic calendar clock, set to local time consistent
- 22、 Password access management: the panel has one administrator password 16 user password, The administrator password primarily for system administrators to set up the alarm system; The user passwords for users in the day-to-day use such arm/ disarm,remote operation. The administrator password, user password can be freely modified.
- 23、 For CMS networking alarm, depending on the number of users, the user can set four, six or eight user codes(account number).
- 24、 Zone type identification:After an alarm is triggered, the alarm zone number displayed on the LCD screen of the panel, also can send the detailed report to CMS which includes alarm locations and zone types.
- 25、 AI-proof function:If try to cut off the wire between wired detector and panel or cut off the tel line which.



- 26、 The tampering alarm: cut the cable between wired detectors and the panel will trigger alarm, the telephone line cut will automatically trigger siren alarm. When someone deliberately dismantled the panel, it will alarm when triggering tamper switch at the back of the panel.
- 27、 Timing arm/disarm: Enable set 4 group time arm/disarm time.
- 28、 CMS communications test: The panel will send a message to CMS at the pre-set time interval to inspect the communication if normal.
- 29、 Siren options: Built-in siren, external wired siren, Wireless siren. All sirens can be programmed as enabled/disabled when alarms.
- 30、 The voice speaker volume adjustment: adjust the volume by a rotary switch on the panel.
- 31、 Wireless repeater function: can extend the distance between the detector and the panel by adding a wireless repeater of our company.
- 32、 The wireless detector low battery prompted: Detectors will send status report to the panel every 1-3 hours, the corresponding zone number and the battery voltage symbol will be displayed on the LCD screen and also will report to CMS.

# Chapter 2 Installation and Connection

## 2.1 Installation

1. Fix the bracket to the wall and hang the pane to the bracket
2. The large metal objects can not be placed around the panel, so as not to affect the wireless signal.
3. Make sure to place the panel within the wireless range of all wireless accessoris and pay attention to the hidden

## 2.2 Connection(N.O. N.C)

As pictures

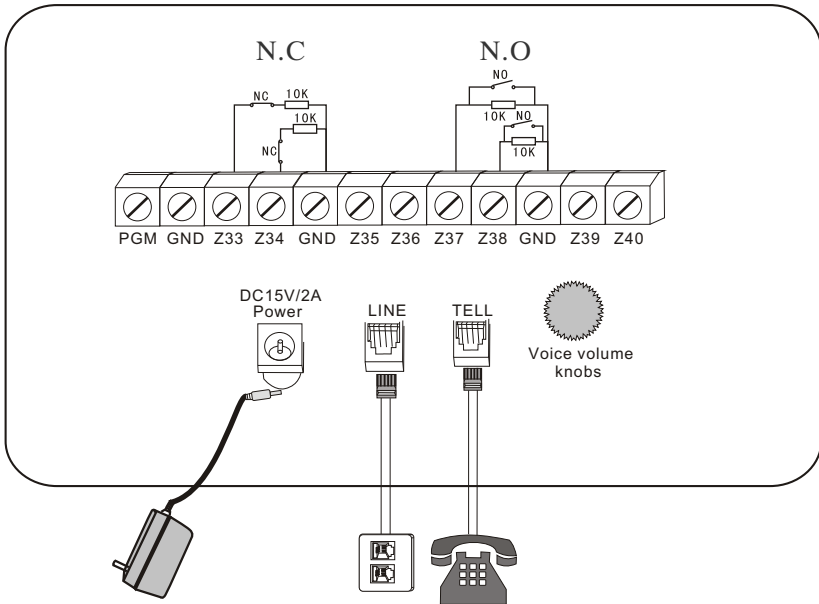

Here only introduce the zone 33, 34, 37, 38. The other zones please refer to the above.

## 2.3 Install wired detector

- 2.3.1 The wired zones is disabled factory default. when to use wired zones please enable the zones firstly. When wired zones is in trouble, the panel will voice prompt "operation fails, Zone trouble" if users try

To arm the panel. The zone number will be also display on the LCD screen. At this time arm system is not allowed unless you force arm.

2.3.2 The control pane can power 15V, 100mA to detectors. The max curent is 100mA. Do not exceed 100mA, otherwise please use extra power supply.

## 2.4 Intall wereless detector

2.4.1 As the detector`s manual says,install coded detector in the area 150m from the control panel.Please test and make sure detector can work with control panel normally.

2.4.2 Wireless repeater function:when wireless detector is too far from the panel or some occluders between panel and detector which disable the panel receive the signal from wireless detector.Now you can choose our made wireless repeater to achieve wireless signal relay trans mitting.

# Chapter 3 Keybad and Operation

## 3.1 Aboutpanel

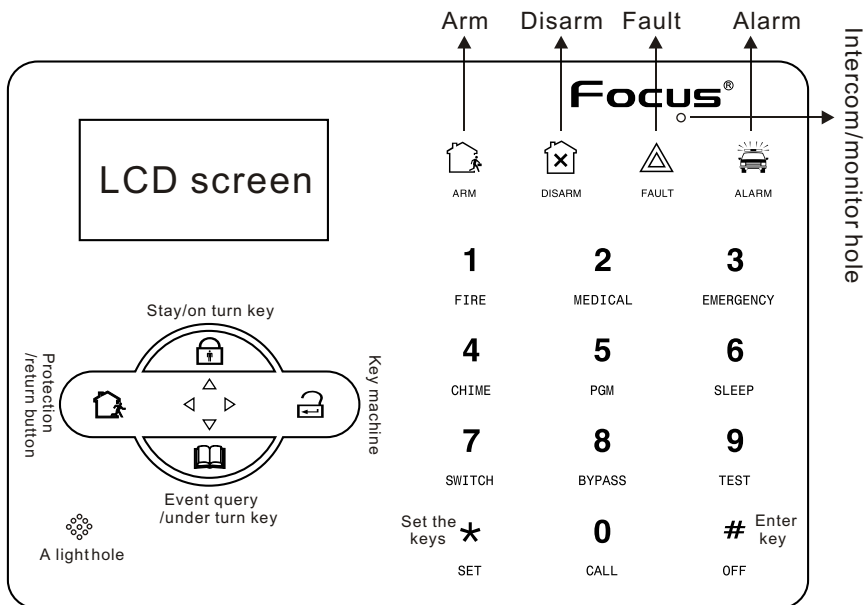

Arm led: Light on under armed status, Light flashes under stay status.

Disarm led: Light on under disarmed status

Trouble led: Light on when with zone trouble. Light flashes when AC cut.

Alarm led: Light flashes when alarm.

- 1 : Press 3 seconds to trigger fire alarm
- 2 : Press 3 seconds for medical help
- 3 : Press 3 seconds for SOS
- 4 : Press 3 seconds then enter user code to enable or disable delay zone doorbell(Refer to page 36)
- 5 : Press 3 seconds then enter user code to enable or disable PGM output(refer to page 30)
- 6 : Press 3 seconds to enter or exit sleep mode.
- 7 : Press 3 seconds then enter user code to enable or disable electrical switch.
- 8 : Press 3 seconds then enter user code to bypass zones or activate zones.
- 9 : Press 3 seconds then enter user code to proceed normal testing, siren testing and walk testing.
- 10 : Press 3 seconds to make phone call through GSM, the longest talk time is 240 seconds. the call will be interrupted when alarm occurs.

Sleep mode: all led indicators, backlight, voice, remind tone will be disabled under sleep mode, The panel will exit sleep mode automatically when users enter system setting or when alarm occurs.

Bypass zone: bypassed zones means zones disabled. The bypass will be restored when users disarm systems under home armed or armed status.

Communication test: To test the communication between the panel and the CMS if normal

Siren test: to test if siren working normal

Walk test: to test if the detectors are working normally with the panel and alarm

### 3.2 Basic operation

Factory default

Adminitrator password: 012345



16 User passwords, NO. 01 factory default is 1234. No. 02-16 of the user password is blank and can not enter the user setting untill user set the password.



Disarm: User password[1234]+DISARM



Home arm: Home arm key

Arm: Arm key

Event log: inquiry key

Shutdown operation: AC power-off state ( press and hold for more than 3 seconds) + userpassword [1234]+ 











Enter system setting:  press and hold for more than 3 seconds+ administrator password [012345]+ 

Enter user setting:  Press and hold for more than 3 seconds+ user NO. (01) +user password(1234)+ 

Zone inspection: Not insepct wired zones within one minutes of panel power up

Password reset: Enter 000000 to enter system setting menu within one minute of panel power up.

### 3.3 Flashes when phone line cut. Light on when phone line is normal.

Icon	Meaning	Icon	Meaning
	GSM signal strength		GSM is enabled
	Telephoneline		Left behind
	Detector low battery		Disarm
	PANEL low battery		Arm
	Alarm		Enable GPRS
	Voice prompts		



Flashes when phone line cut. Light on when phone line is normal.



Flashes when GSM not ready, Light on when GSM is normal.



Flashes when GPRS disconnected with CMS. Light on when GPRS is connected well with CMS.



Flashes under sleep mode. Light on under normal working mode.

**A-05** Zone 5 alarm

**F-05L** Zone 5 detector lost

**F-05E** Zone 5 trouble

**F-05** Zone 5 low battery

**P-05** Zone 5 bypass

The alarm zone number will still be displayed on LCD screen after first disarm when alarm occurs, returned to normal screen display only users disarm twice.

### 3.4 Host arm and disarm

☆ Arm

Press the key for arm away on remote or the keypad, then you hear "system armed, please exit the protection area" there will be "Dee-dee" sound to confirm the system is armed successfully.

☆ Disarm

Press the disarm key on the remote or enter your user password on the keypad, then you will hear "dee" and voice "system disarmed", then you have disarm successfully.

☆ Home Arm

Press the key for home arm on the remote or "HOME" key on the keypad, then you will hear "system stay" And it display home arm icon on the LCD screen.

☆ Panic

Press the panic button on remoter, or press "3" key on panel for 3 seconds.

The codes of arm/disarm via different ways:

Arm/disarm via keyfobs: 1-8 keyfobs---#40-47

Arm/disarm via user codes: 1-16 user codes---#01-16

Arm/disarm via phone call: 1-4 user phone number---#60-63

Arm/disarm via CMS: #97

Arm/disarm via home arm key or arm key in panel: #98

Auto arm/dsiamr via auto timer or key zone: #99

### 3.5 Alarm procedure

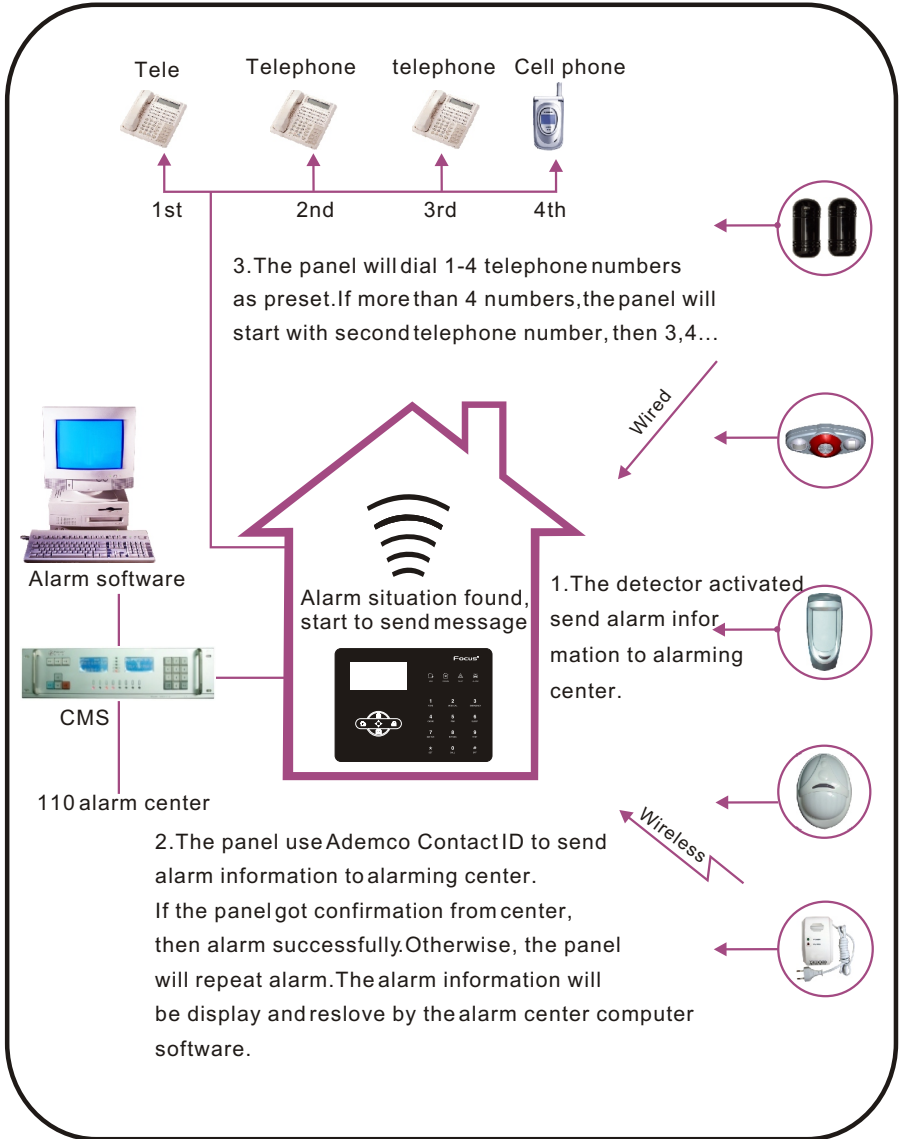



## Chapter IV Voice alarm receiving and GSM control

### 4.1 Remote phone control

User can remote control the system by phone call, after the preset ringing times then panel will off hook the phone then enter the 4 digit user codes according to voice prompting and operate as per the voice prompting.

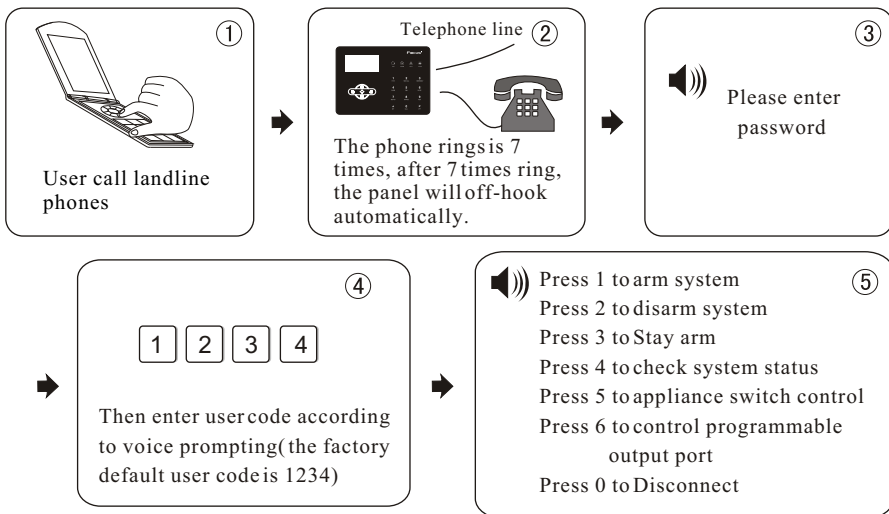

### 4.2 Alarm receiving phone operation

When alarm, the panel will dial the pre-set voice phone number, when the user pick up the call, they will hear the voice prompting as below, if not press 1 to cancel the alarm or press 4 to disarm the system, after off-hook, the panel will call other preset voice phone numbers.

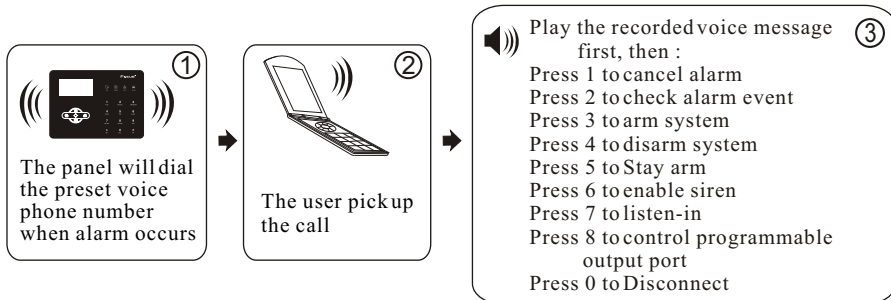

### 4.3 GSM remote operation ( talk-back function added)

When alarm occurs, GSM will call the preset voice number, when pick up the call, enter 4 digit user code, then voice prompt: Press 1 to arm system, Press 2 to disarm system, Press 3 to Stay arm, Press 4 to check system status, Press 5 to appliance switch control, Press 9 to talk-back, Press 0 to Disconnect.

### 4.4 GSM alarm receiving (talk-back function added)

When alarm occurs, it will send SMS first, then call the preset voice number, when pick up the call, it will play the recorded voice message first, then voice prompt: Press 1 to cancel alarm, Press 2 to check alarm event, Press 3 to arm system, Press 4 to disarm system, Press 5 to Stay arm, Press 6 to enable siren, Press 7 to listen-in, Press 8 to control programmable output port, Press 9 to talk-back, Press 0 to Disconnect.

### 4.5 GSM control via SMS

Arm command: `password:1234system arm`

Disarm command: `password:1234system disarm`

Stay command: `password:1234 system home`

Cancel alarm command: `password:1234 system cancel`

Status checking command: `password:1234 system status`

Enable programmable output port command: `password:1234 pgm open`

Disable programmable output port command: `password:1234 pgm close`

Enable appliance switch command:

`password:1234 switch open X(X=1-8 on behalf of appliance switch number)`

Disable appliance switch command:

`password:1234 switch close X(X=1-8 on behalf of appliance switch number)`

Set apn: `password:1234 apn: "aaa"`

Set ID: `password:1234 user: "bbb"`

Set password: `password:1234 pwd: "ccc"`

Note: the factory default user code is 1234, when arm successfully, SMS auto reply "arm successfully", if the password is correct, the command is not correct, SMS will reply "operation failure", if the password is not correct, no SMS reply.

## Chapter IV Voice alarm receiving and GSM control

Press[\*] for 3 seconds

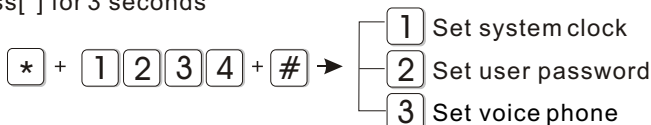

### 5.1 Set system clock

For example: set system clock as : 22:59:36 22/12/2012

Press[\*] for 3 seconds

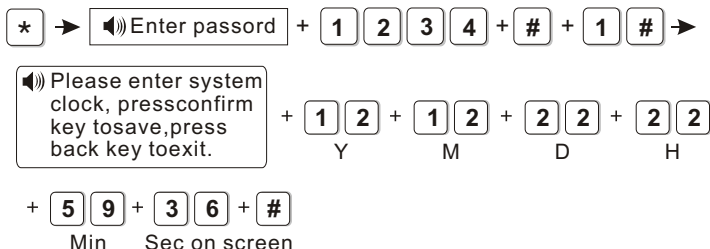

According to flash of Y.M.D.H.Min.Sec on screen, enter 12.12.22.22.59.36 by turn, also can press [UP] [DOWN] key to move cursor.

### 5.2 Set user password

For example: Set No.16 user pasword as 5678

Press[\*] for 3 seconds

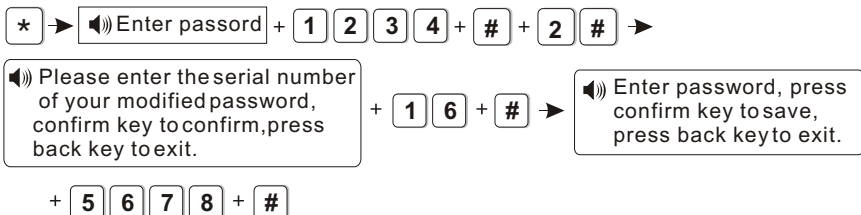

Note: Can set 16 user passwords, corresponding password No. from 01 to 16,

Only No.1 password can enter user setting.

### 5.3 Set voice phone (refer to page 15)

# Chapter VI System Setting

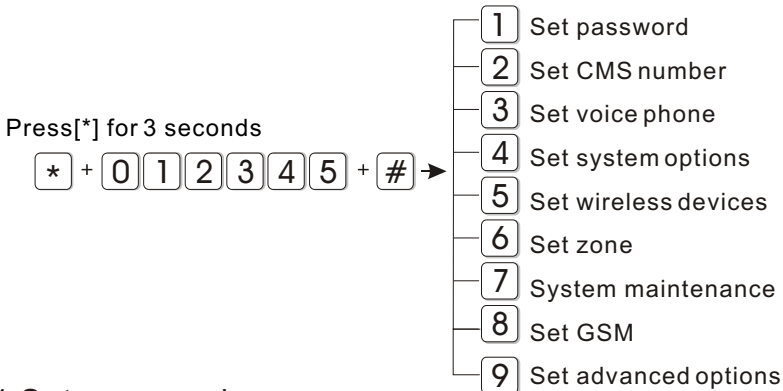

## 6.1 Set password

Press[\*] for 3 seconds

\* + 0 1 2 3 4 5 + # + 1 # Then operate according to the voice prompt as below.

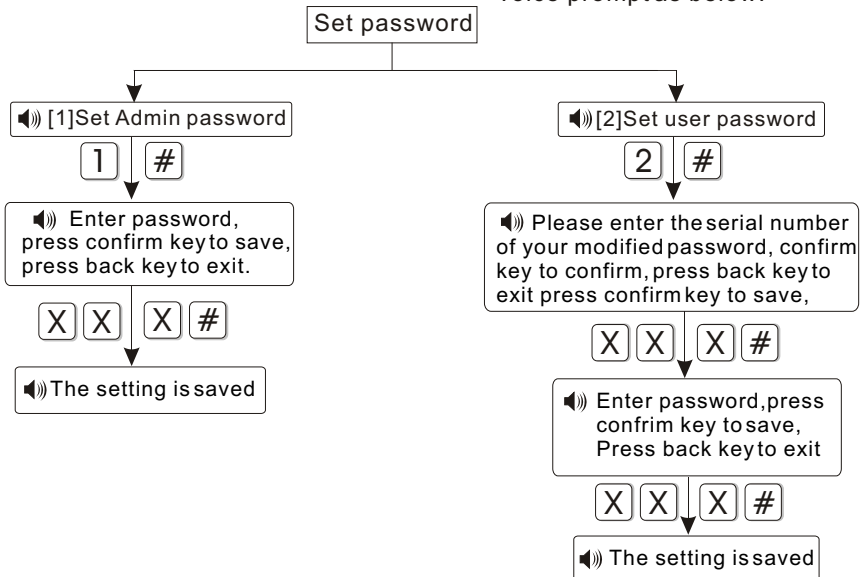

Note: 1. password setting include “user password” and “ administrator password” , user password mainly use to disarm the system, it is a private key for remote controlling, “administrator password” is the sole password to set the system.

2. Administrator password is 6 digit, userpassword is 4 digit, can set 16 user passwords, corresponding password No. from 01 to 16, but No.2-16password can't enter user setting.
- 3.If forgot the password, when the alarm is powered on, for the first minute,the administrator password is 000000.  
For example: Setadmin pasword as 888888

Press[\*] for 3 seconds

\* → Enter password + 0 1 2 3 4 5 + # + 1 # + 1 #

→ Enter password,press confirm key to save, press back key to exit + 8 8 8 8 8 8 + #

- Note: 1.Above base on the correct operation, if incorrectoperation occurs, please press back key to back previousmenu to reset.
- 2.The factory default of admin password is 9876, userpassword is 1234,if you have modified thepassword, please refer to the newpassword.

## 6.2 Set CMS number

Press[\*] for 3 seconds

\* + 0 1 2 3 4 5 + # + 2 # Then operate according to the voice prompt as below:

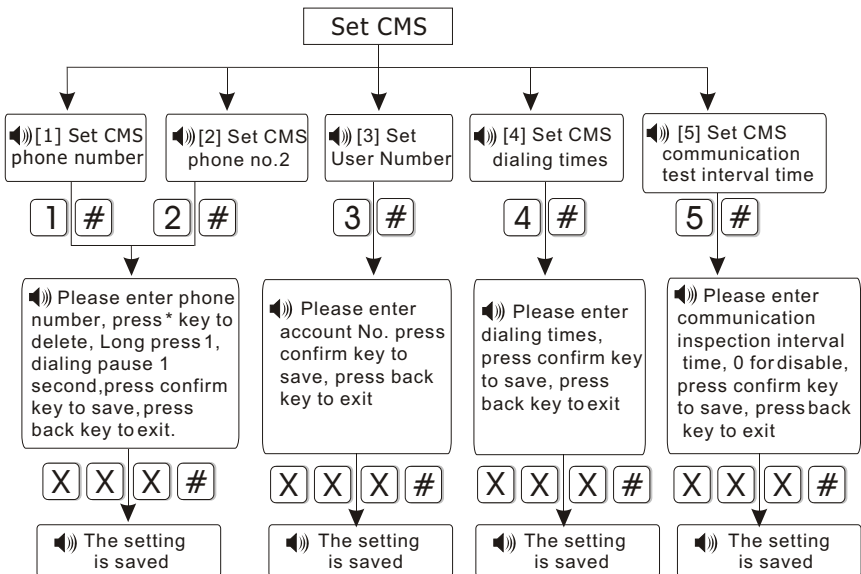

Note: 1.The user code is the identification code in CMS setting, CMS 1 and CMS 2 use the same user code; dialing times can be set 1-15 , communication inspection interval time can be set 0-999 hours, the common setting is 24 hours.

2.When set phone number, long press 1, display the letter P, means pause 1 second when dialing, when the telephone line which connect to the alarm panel is sub-line, need a pause dialing.

3.For GSM, just recognize the number behind P, can make sure telephone and GSM dial the same number.

For example: the sub-line connect to alarm panel, CMS number is 80808080, in this way, set CMS number like this 9P80808080, 9 is out code.

Press[\*] for 3 seconds

\* → Enter password + 0 1 2 3 4 5 + # + 2 # + 1 #

→ Please enter phone number, press \* key to delete, Long press 1, dialing pause 1 second, press confirm key to save, press backkey to exit. + 9 1 8 0 8 0 8 0 8 0 + #

Press[1] key for 3 seconds.

### 6.3 Set voice phone

Press[\*] for 3 seconds

\* + 0 1 2 3 4 5 + # + 3 # Then operate according to the voice prompt as below:

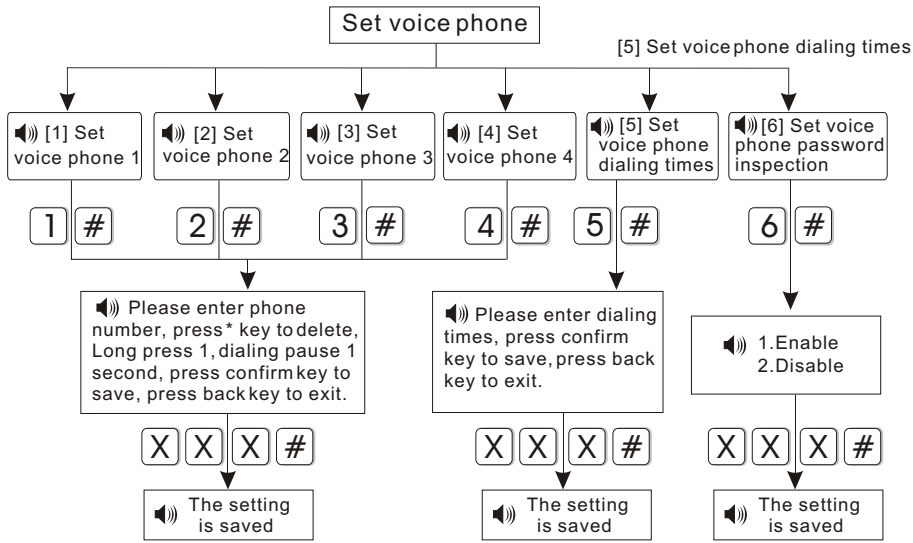

Note:1.dialing times can set 1-15

2.When panel call user' s phone, if you enable password check, it will prompt enter user password when pick up the call.

For example: Set voice phone No.3 is 12345678

Press[\*] for 3 seconds

\* → Enter password + 0 1 2 3 4 5 + # + 3 # + 3 #

→ Please enter phonenumber, press \* key to delete, Long press 1, dialing pause 1 se cond, press confirm key to save, press backkey to exit.

+ 1 2 3 4 5 6 7 8 + #

## 6.4 Set system options

Press[\*] for 3 seconds

\* + 0 1 2 3 4 5 + # + 4 #

- 1 Set system clock
- 2 Set entry delay
- 3 Set exit delay
- 4 Set siren time
- 5 Set ring times
- 6 Set detector lossinspection
- 7 Set arm/disarm tone
- 8 Set arm/disarm report
- 9 Set others

### 6.4.1 Set system clock

For example: Set system time to 22:59:36 22/12/2012

Press[\*] for 3 seconds

\* → Enter password + 0 1 2 3 4 5 + # + 4 # + 1 # →

Please enter system clock, press confirm key to save, press back key to exit.

+ 1 2 + 1 2 + 2 2 + 2 2 + 5 9

Y M D H Min

+ 3 6 + #

Sec on screen

According to flash of Y.M.D.H.Min.Sec on screen, enter 12.12.22.22.59.36 by turn, also can press [UP][DOWN] key to move cursor.

### 6.4.2 Set entry delay

When trigger alarm, the panel will give delay alarm time (default setting is 10s)

For example: Set entry delay to 20 seconds

Press[\*] for 3 seconds

→ Enter password + + + +

Please enter entry delay time, press confirm key to save, press back key to exit + +

Enter 3 digit number from 0-255, add 0 if less than 3 digit.

Note: Entry delay is just effective for delay zone. Other zone types can't enter delay.

### 6.4.3 Set exit delay

After user armed the system, it is convenient for user to exit the area after arm successfully. (the default setting is 10 seconds)

For example: Set exit delay time is 20s

Press[\*] for 3 seconds

→ Enter password + + + +

Please enter exit delay time, press confirm key to save, press back key to exit + +

Enter 3 digit number from 0-255, add 0 if less than 3 digit.

6.4.4 Set siren time :The siren ring time after alarm is triggered (the default setting is 5 minutes)

For example: Set siren time is 10 minutes

Press[\*] for 3 seconds

→ Enter password + + + +

Please enter 0 to 30 minutes siren time, press confirm key to save, press back key to exit + +

### 6.4.5 Set ring times

User remote control alarm panel, dial the preset phone number, the panel will off-hook after phone ring times (the default setting is 7 times)

For example: Set ring times is 5



Press[\*] for 3 seconds

\* → Enter password + 0 1 2 3 4 5 + # + 4 # + 5 #

→ Enter password... Please enter ring times, if set as 0, the phone will not off hook, press confirm key to save, press back key to exit + 0 5 + #

Enter 2 digit number from 0-15, add 0 if lower than 10.

Note: The max. Ring times as per the local communication, if set 0, not off-hook.

#### 6.4.6 Set detector loss inspection

The alarm panel will inspect the detectors' status or alarm info in this time interval, if not receive, it is determined that the detector is loss, the general setting is not less than 6 hours (the default setting is 0, disable this function)

For example: Set detector loss inspection time is 8 hours.

Press[\*] for 3 seconds

\* → Enter password + 0 1 2 3 4 5 + # + 4 # + 6 #

→ Please enter 0 to 99 hours detector loss inspection time, 0 for disable, press confirm key to save, press back key to exit + 0 8 + #

#### 6.4.7 Set arm/disarm tone

When user arm/disarm the system through remote control, if siren will sound or not for prompting. (the default setting is disabled)

For example: Set siren with short sound when arm/disarm through remote control.

Press[\*] for 3 seconds

\* → Enter password + 0 1 2 3 4 5 + # + 4 # + 7 #

→ Please choose arm/disarm tone: 1. siren short sound 2. no voice, press confirm key to save, press back key to exit + 1 + #

### 6.4.8 Set arm/disarm report

Set if arm/disarm report to CMS or not( the default setting is disabled)

For example: Set arm/disarm report to CMS

Press[\*] for 3 seconds

\* → Enter password + 0 1 2 3 4 5 + # + 4 # + 8 #

→ Please choose arm/disarm report: 1. enable, 2. disable, press confirm key to save, press back key to exit + 1 + #

### 6.4.9 Set others

\* + 0 1 2 3 4 5 + # + 4 # + 9 # →

- 1 Set emergency alarm siren type
- 2 Set ACoff inspection time
- 3 Enable magnetic contact inspection
- 4 Check wireless detector tamper
- 5 Set force arm
- 6 Set telephone line disconnect remind
- 7 Set zone alarm times
- 8 Set listen-in time
- 9 Set AC off remind

#### 6.4.9.1 Set emergency alarm siren type( the default setting is mute)

For example: set emergency alarm siren type is pedal point.

Press[\*] for 3 seconds

\* → Enter password + 0 1 2 3 4 5 + # + 4 # + 9 #

+ 1 # → Please choose zone siren type: 1.pedal point 2.pulse tone 3. mute, press confirm key to save, press back key to exit + 1 + #

6.4.9.2 Ac off inspection time setting. When the AC power is off, delay to report to CMS(factory default delay time is 30 min)

Example: set AC off inspection time as 15 min

Press[\*] for 3 seconds

\* → Enter password + 0 1 2 3 4 5 + # + 4 # + 9 #

+ 2 # → Please enter 0 to 255 minutes AC off duration time.press confirm key to save, press back key to exit. + 0 1 5 + #

6.4.9.3 Magnetic contact inspection: Set if the alarm panel show zone trouble on LCD screen or not when sperate the magnetic strip from transmitter. (Factory default disable the inspection)

Example: enblae the magnetic contact inspection

Press[\*] for 3 seconds

\* → Enter password + 0 1 2 3 4 5 + # + 4 # + 9 #

+ 3 # → Please choose: 1. Enable magnetic contact inspection 2. Disable Press confirm key to save, Pressback key to exit. + 1 + #

6.4.9.4 Check wireless detector tamper: if the enable the checking when trigger the detector' s tamper , will trigger alarm. If disable the checking, it will not trigger alarm.(factory default enable the checking)

Example: disable the checking of wireless detector tamper.

Press[\*] for 3 seconds

\* → Enter password + 0 1 2 3 4 5 + # + 4 # + 9 #

+ 4 # → Please choose : 1. Enable wireless detector tamper inspection,2. Disable Press confirm key to save, Pressback key to exit. + 2 + #

6.4.9.5 Set force arm: if enabel set force arm, when there is zone trouble, the system can be armed and report the trouble zone' s bypass message to CMS. If disable the force arm, the system can not be armed(factory default is disable forem arm)

Example: enabel force arm



Press[\*] for 3 seconds

\* → Enter password + 0 1 2 3 4 5 + # + 4 # + 9 #

+ 5 # → Please choose: 1.Auto force arm  
2. Forbid force arm via remote control.Press confirm key to save, pressback key to exit. + 1 + #

#### 6.4.9.6 Set telephone line disconnect remind(factory default delayed siren sound remind)

Example : disable telephone line disconnet remind

Press[\*] for 3 seconds

\* → Enter password + 0 1 2 3 4 5 + # + 4 # + 9 #

+ 6 # → Please choose telephone line disconnect remind:  
1. Siren delay remind,  
2. Buzzer remind,3 disable  
Press confirm key to save,  
Pressback key to exit. + 3 + #

#### 6.4.9.7 set zone alarm times: if set the alarm alarm times as 1, when zone start alarm but the zone is trigger one time again, the panel will not make alarm.

Example: set zone alarm times as 1 time

Press[\*] for 3 seconds

\* → Enter password + 0 1 2 3 4 5 + # + 4 # + 9 #

7 # → Please choose zone alarm times:  
1. no limited 2. 1 time  
Press confirm key to save,  
Pressback key to exit. + 2 + #

#### 6.4.9.8 set listen-in time(factory default 10 sec)

Example: set listen-in time as 20sec

Press[\*] for 3 seconds

\* → Enter password + 0 1 2 3 4 5 + # + 4 # + 9 #

+ 8 # → Please enter 10to 255 seconds listen-in time  
Press confirm key to save,  
Pressback key to exit. + 0 2 0 + #

### 6.4.9.9 Set AC off remind (factory default remind by SMS)

Example: disable AC off remind

Press[\*] for 3 seconds

\* → Enter password + 0 1 2 3 4 5 + # + 4 # + 9 #

+ 9 # → Please choose AC off remind:  
1. SMS remind 2. Voicephone remind 3. Disable  
Press confirm key to save, Pressback key to exit.

+ 3 + #

## 6.5 manage wireless device

Press[\*] for 3 seconds

\* + 0 1 2 3 4 5 + # + 5 # →

- 1 Set remote control
- 2 Set detectors
- 3 Set appliance switch
- 4 Enroll wireless siren
- 5 Set door bell

### 6.5.1 set remote control

Press[\*] for 3 seconds

\* + 0 1 2 3 4 5 + # + 5 # + 1 # →

- 1 Enroll remote control
- 2 Enter remote control code
- 3 Delete remote control

#### 6.5.1.1 enroll remote control

Example: enroll remote to the #3 remote in alarm panel

Press[\*] for 3 seconds

\* → Enter password + 0 1 2 3 4 5 + # + 5 # + 1 #

+ 1 # → Please enter the serial number of remote control  
Press confirm key to save, Pressback key to exit.

+ 3 + # → Please trigger the remote control  
Pressback key to exit.

→  → Enroll successful + #

Trigger arming key on the remote control

### 6.5.1.2 enter remote control code

Example: manual enter the address code of remote 112113114 to the #8 remote in alarm pa

Press[\*] for 3 seconds

\* → Enter password + 0 1 2 3 4 5 + # + 5 # + 1 #

+ 2 # → Please enter the serial number of remote control. Press confirm key to save, Pressback key to exit. + 8 + # →

Please enter remote control Number Press confirm key to save, Pressback key to exit. + 1 1 2 1 1 3 1 1 4 + #

### 6.5.1.3 delte remote control

Example: delete the # 5 remote

Press[\*] for 3 seconds

\* → Enter password + 0 1 2 3 4 5 + # + 5 # + 1 #

+ 3 # → Please enter the serial number of remote control to delete, enter 0 to delete all. Press confirm key to save, Pressback key to exit. + 5 + #

### 6.5.2 set detector

Press[\*] for 3 seconds

\* + 0 1 2 3 4 5 + # + 5 # + 2 # →

- 1 Detector coding
- 2 Enter detector code
- 3 Delete detector

#### 6.5.2.1 detector coding

Example: auto code detector to #9 detector in alarm panel

Press[\*] for 3 seconds

\* → Enter password + 0 1 2 3 4 5 + # + 5 # + 2 #

+ 1 # → Please enter detector Number Press confirm key to save, Pressback key to exit. + 0 9 + # → Please trigger the detector Pressback key to exit.

→ trigger the detector → Enroll successful + #

### 6.5.2.2 enter detector code

Example: manual enter the address code of detector 011022033 to the #7 detector in alarm panel

Press[\*] for 3 seconds

\* → Enter password + 0 1 2 3 4 5 + # + 5 # + 2 #

+ 2 # → Please enter detector Number. Press confirm key to save, Pressback key to exit. + 0 7 + # →

Please enter detector code Press confirm key to save, Pressback key to exit. + 0 1 1 0 2 2 0 3 3 + #

### 6.5.2.3 delete detector

Example: delete the #3 detector

Press[\*] for 3 seconds

\* → Enter password + 0 1 2 3 4 5 + # + 5 # + 2 #

+ 3 # → Please enter the serial number of detector to delete, enter 00 to delete all. Press confirm key to save, Pressback key to exit. + 0 3 + #

## 6.5.3 set appliance switch

Press[\*] for 3 seconds

\* + 0 1 2 3 4 5 + # + 5 # + 3 # →

- 1 Enroll appliance switch
- 2 Delete appliance switch

### 6.5.3.1 enroll appliance switch

Example: auto the appliance to the #1 switch in alarm panel

Press[\*] for 3 seconds

\* → Enter password + 0 1 2 3 4 5 + # + 5 # + 3 #

+ 1 # → Please enter the serial number of appliance switch Press confirm key to save, Pressback key to exit. + 1 + # → Please trigger appliance switch Pressback key to exit.

→ Trigger appliance switch → Enroll successful + #

### 6.5.3.2 Delete appliance switch

Example: delete the # 4 appliance switch

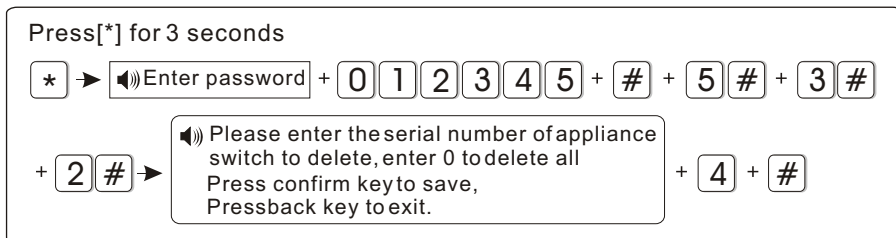

### 6.5.4 Enroll wireless siren



#### 6.5.4.1 Enroll wireless siren

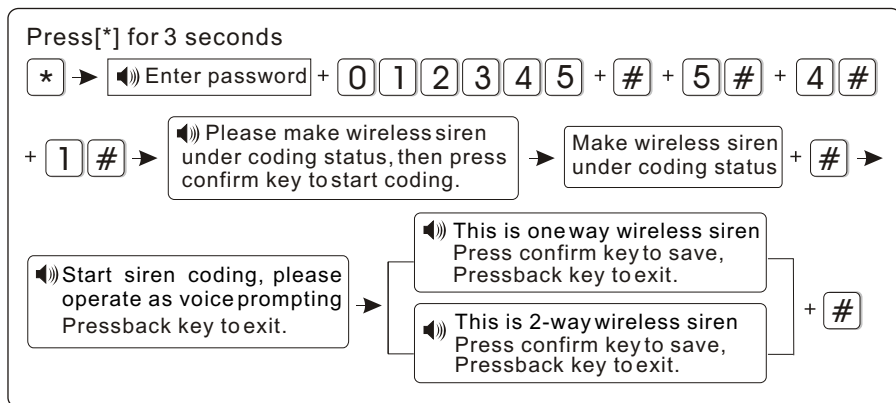

NOTE: when dual-way wireless siren make tamper alarming, the LCD screen of alarm panel will display zone 41 alarming.

#### 6.5.4.2 Delete wireless siren

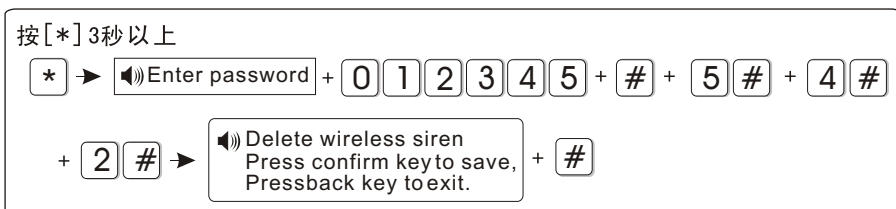

Note: It is dual-way wireless siren deleted.



## 6.6.5 Set door bell

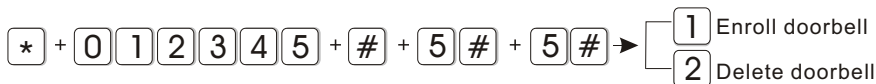

### 6.5.5.1 Enroll doorbell

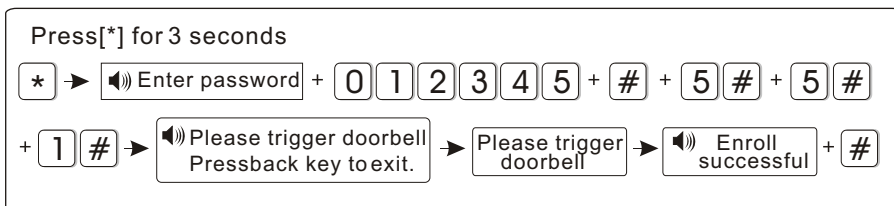

Note: can only learn a wireless doorbell, the trigger will be issued after the chink

### 6.5.5.2 Delete doorbell

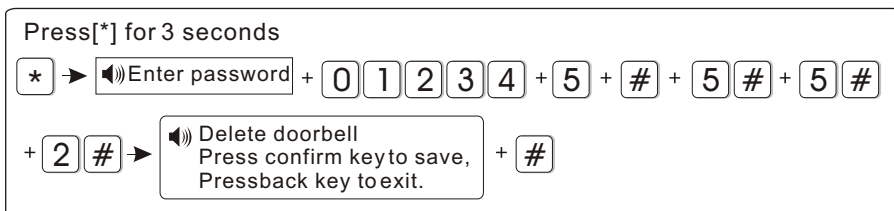

## 6.6 Sector Settings

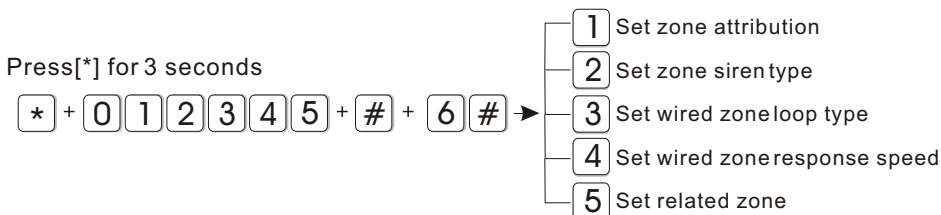

### 6.6.1 set zone attribution

The type of zone attribution is as below:

- |                |                  |                   |
|----------------|------------------|-------------------|
| 0)disable zone | 1> delay zone    | 2> perimeter zone |
| 3>inerior zone | 4>emergency zone | 5> 24 hours zone  |
| 6>fire zone    | 7> key zone      |                   |

1.Zone attribution is the alarm type of the zone display on the alarm panel's LCD screen when the zone is triggered. When set the zone attribution as 0 is to disable the zone. The alarm panel will not make alarm when trigger this zone.

- 2.interior zone only trigger alarm when the zone is triggered under system at armed status.
- 3.delay and perimeter zone trigger alarm when the zone is triggered under system at armed or home arm status.
- 4.emergency zone, 24 hours zone, fire zone will trigger alarm when system at any status
- 5.wireless zone can not set key zone type. When wired zone is set as keyzone, trigger the zone, system turn to disarm status. The zone restore, system turn to armed status. This is for access control system.

Example: set zone 39 as keyzone type

Press[\*] for 3 seconds

\* → Enter password + 0 1 2 3 4 5 + # + 6 # + 1 #

→ Please enter the zone No. to modify.  
Press confirm key to save,  
Pressback key to exit. + 3 9 + # →

Please choose zone type:  
0. Disable the zone 1. Delayzone 2. Perimeterzone 3. Interiorzone  
4. Emergency zone 5. 24 hourszone 6. Firezone 7. Keyzone + 7 + #

### 6.6.2 set zone siren type(factory default is pedal point)

Example set zone 23' s siren type as pulse tone

Press[\*] for 3 seconds

\* → Enter password + 0 1 2 3 4 5 + # + 6 # + 2 #

→ Please enter the zone number to modify.  
Press confirm key to save,  
Pressback key to exit. + 2 3 + # →

Please choose zone siren type:  
1.pedal point 2.pulsetone 3. Mute  
Press confirm key to save,  
Pressback key to exit.

+ 2 + #

### 6.6.3 set wired zone loop type(factory default EOL )

The options is as below:

- 1>EOL loop type: when the resistor value is 10k on the zone is normal, when the zone is open loop or shortcut trigger alarm
- 2>N/C loopytype: zone shortcut is normal, open loop trigger alarm
- 3>N/O loop type: zone open loop is normal, shortcut loop trigger alarm

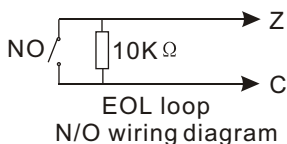
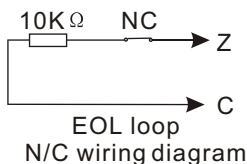

Example: set zone 35 as N/O loop type

Press[\*] for 3 seconds

\* → Enter password + 0 1 2 3 4 5 + # + 6 # + 3 #

→ Please enter the zone number to modify  
Press confirm key to save,  
Pressback key to exit. + 3 5 + # → Please choose looptype:  
1.EOL 2.N/C,3.N/O  
Press confirm key to save,  
Pressback key to exit.

+ 3 + #

#### 6.6.4 set wired zone response speed(factory default is 500 millisecond)

Press[\*] for 3 seconds

\* → Enter password + 0 1 2 3 4 5 + # + 6 # + 4 #

→ Please enter the zone number to modify  
Press confirm key to save,  
Pressback key to exit. + 4 0 + # → Please choose loop response speed:  
1. 500ms,  
2. 10ms  
Press confirm key to save,  
Pressback key to exit.

+ 2 + #

Note: Normal the detector's response speed is 500 millisecond, high speed response detector like vibration detector is 10 millisecond

#### 6.6.5 set related zone: zone 1+zone 2+related time+mode

The options as belows

0>disable related zone mode

1>EXIT-ENTRANCE dual trigger mode: trigger zone 1 or 2 seperately will not trigger alarming. Trigger zone 1 first, then during the period of related time trigger zone 2, then both zone 1 and 2 trigger alarm. Trigger zone 2 first, then trigger zone 1 will not trigger alarm.

2>EXIT-ENTRANCE single trigger model: trigger zone 1, zone 1 make alarm.

Trigger zone 2 first, then during the period of related time trigger zone 1, do not make alarm. Trigger zone 2, then do not trigger zone 1 during related time, then zone 2 make alarm.

3> Dual trigger alarm mode: trigger zone 1 or zone 2 only do not make alarm.

During related time trigger zone 1 or zone 2, then zone 1 or zone 2 make alarm.

Example: set zone 5 and zone 9 as group #4 dual trigger mode related zone, related time is 120sec.

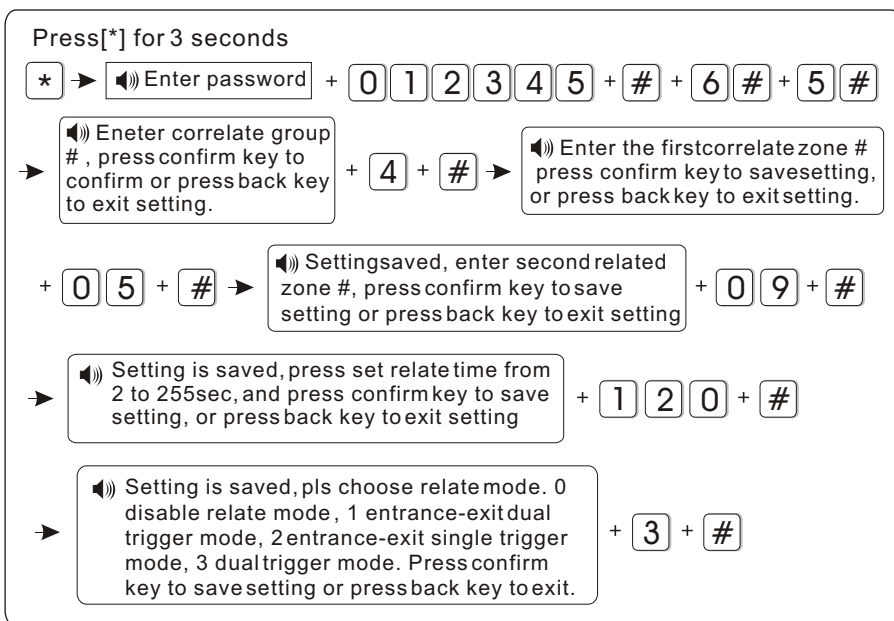

NOTE: max set 4 group relate zone

## 6.7 system maintance

Press[\*] for 3 seconds

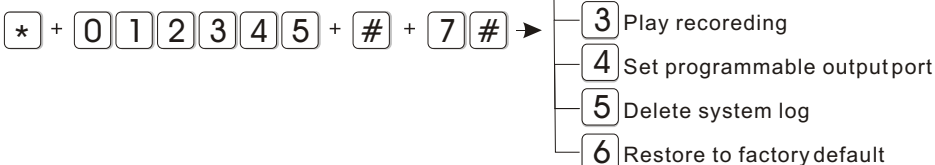

### 6.7.1 Set timing operation

Example: Set group No.3 as timing disarm at 8:30, and timing arm at 17:30

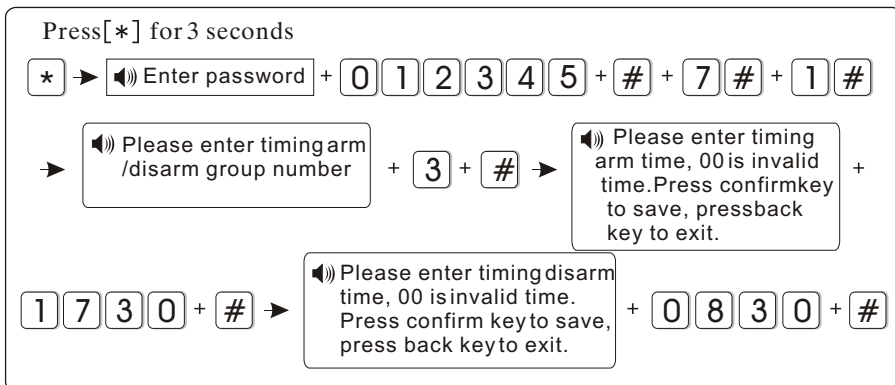

Hint: 4 groups of timing arm/disarm can be set according to the schedule of user.

### 6.7.2 Recording

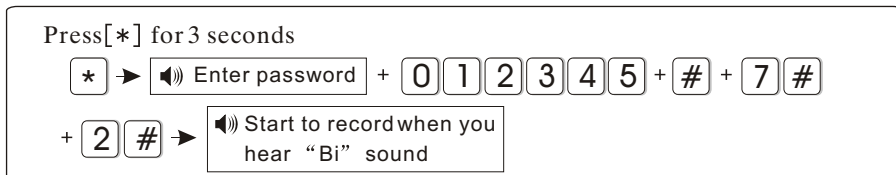

Hint: 15 seconds for recording time. And it will play recording as soon as the panel dial to the telephone No.as preset.

### 6.7.3 Play recording

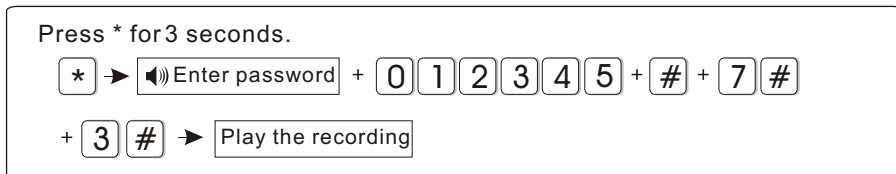

6.7.4. Set programmable output port: the voltage will change from 0V to 14.5V as soon as some events occurs. (Default is follow alarm output)

Trigger events can be set as below

- |                                 |                                      |
|---------------------------------|--------------------------------------|
| 1. Follow alarm output          | 2. Follow arm output                 |
| 3. Follow AC power fault output | 4. Follow communication fault output |
| 5. Password control output      |                                      |

For example: Set as password control output

Press[\*] for 3 seconds

\* → Enter password + 0 1 2 3 4 5 + # + 7 # + 4 #

→ Please select programmable output port follow event  
 1.Follow alarm output 2.Follow arm output  
 3.Follow AC power fault output  
 4.Follow Communication fault output  
 5.Password control output + 5 + #

Hint: when setting as password control output, press key 5 for 3 seconds, then enter the user password, the programme output port will be open or closed. Voice phone or SMS also can open or close the output.

### 6.7.5.Delete system events

Press[\*] for 3 seconds

\* → Enter password + 0 1 2 3 4 5 + # + 7 # + 5 #

→ Please re-confirm to restore to factory default.  
 Press confirm key to save, press back key to exit. + #

### 6.7.6.Restore to factory default

Press \* for 3 seconds

\* → Enter password + 0 1 2 3 4 5 + # + 7 # + 6 #

→ Please re-confirm to restore to factory default.  
 Press confirm key to save, press back key to exit. + #

## 6.8. Set GSM module

Press[\*] for 3 seconds

\* + 0 1 2 3 4 5 + # + 8 # The voice prompt will instruct you to proceed below operations.

For example: Set enable GSM module, telephone line priority, Set GSM bill reminder time is 21st Dec. 2012.

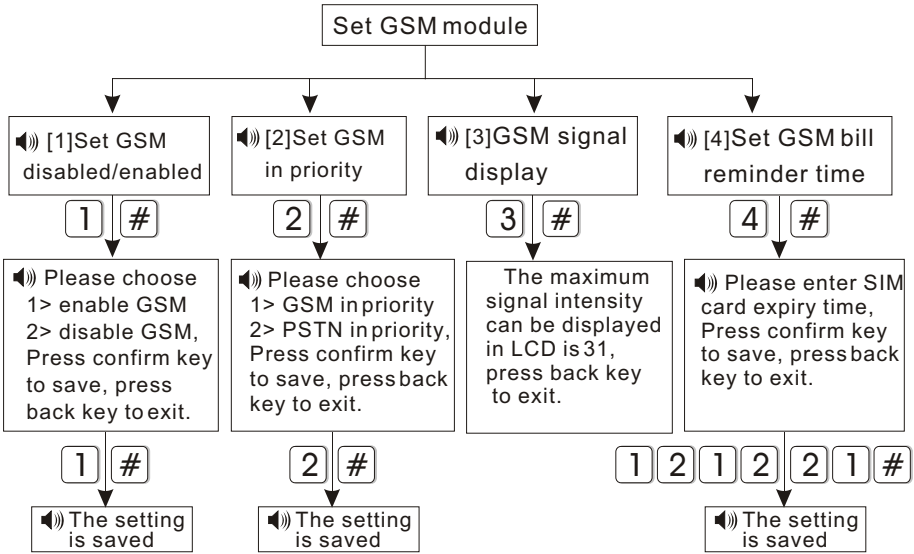

Hint: The alarm control panel will send SMS to cellphone as preset and remind you to recharge as you set GSM bill reminder time before or after ten days.

## 6.9 Advanced setting options

Without voice prompt, programme address and the corresponding options as below table.

01	GPRS enable and disable	
02	Set severIP address	
03	Set severport	
04	Set userID	
05	Set userpassword	
06	GSM SMSlanguage	
07	Delay zonetone source options	
08	Handshake toneinput signal intensity	
09	DTMF outputsignal intensity	
10	Set LCDstandby brightness	
11	Alarm eventretain time	
50	System 00zone	7
51	Delay zone	7
52	Perimeter zone	7
53	Interior zone	7
54	24 Hourzone	7
55	Emergency zone	7
56	Fire zone	7
57	Tamper zone	7
58	Sensor lowbattery	5
59	Sensor recovery	5
60	Sensor loss	5
61	System lowbattery	5
62	SystemAC loss	5
63	SystemAC recovery	5
64	Zone bypass	5
65	Telephone line fault	5
66	Periodic testreport	5
67	Wireless zone loop trouble	0
68	Wireless zone loop recovery	0
69	System battery recovery	0
70	Communication trouble	0
71	Bypass cancel	0
72	Alarm cancel	0
73	Disarm	0
74	Armed stay	0
75	Armed	0
76	Panel programming changed	0
77	System alarm failure	5
78	Telephone line recovery	4
79	Communication recovery	4

Programming address 50-79 are correspond to the options for the alarm content, the right of data are factory default.

Set alarm data as below:

0. Do not send any information
1. Only send SMS.
2. Only telephone line
3. SMS+telephone line
4. Only upload to CMS
5. Upload to CMS+SMS
6. Upload to CMS+telephone line
7. Upload to CMS+SMS+telephone line



### LCD display direction

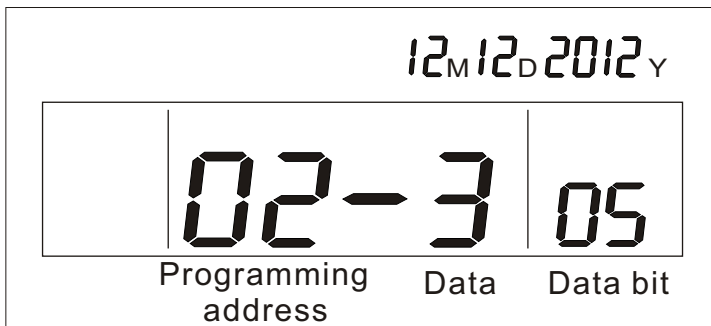

Press key up and down to check and modify the different data of the data bit.

### 6.9.1 GPRS enable and disable (1. Enable 2. Disable default is 2)

For example: set enable GPRS

Press[\*] for 3 seconds

\* → Enter password + 0 1 2 3 4 5 + # + 9 # →

LCD display: -- -- 00 + Programming address: 0 1 + Data: 1 + LCD display: 01-101 + #

Hint: Priority to enable the GSM module before enable the GPRS

### 6.9.2 Set sever IP address

For example: Sever IP address is 103.59.108.3

Press[\*] for 3 seconds

\* → Enter password + 0 1 2 3 4 5 + # + 9 # → LCD display: -- -- 00

+ 0 2 + 1 0 3 + 0 5 9 + 1 0 8 + 0 0 3 → LCD display: 02-3|12

+ # Less than 3 bits high zero.

### 6.9.3 Set sever port

For example: Sever port as 80808

Press[\*] for 3 seconds

\* → Enter password + 0 1 2 3 4 5 + # + 9 # →

\_\_-\_\_00 + 0 3 + 8 0 8 0 8 → 03-808 + #

### 6.9.4 Set user ID

For example: User ID as 50505050

Press[\*] for 3 seconds

\* → Enter password + 0 1 2 3 4 5 + # + 9 # →

\_\_-\_\_00 + 0 4 + 5 0 5 0 5 0 5 0 → 04-008 + #

User ID must be 8 bits

### 6.9.5 Set user password

For example: User password as 12345678

Press[\*] for 3 seconds

\* → Enter password + 0 1 2 3 4 5 + # + 9 # →

\_\_-\_\_00 + 0 5 + 1 2 3 4 5 6 7 8 → 05-808 + #

User password must be 8 bits

### 6.9.6 GSM SMS language (1. Chinese 2. English Default is 1 Chinese)

For example: Set GSM SMS language as English

Press \* for 3 seconds

\* → Enter password + 0 1 2 3 4 5 + # + 9 # →

\_\_-\_\_00 + 0 6 + 2 → 06-201 + #

### 6.9.7 Delay zone tone source options

1. Dingdong 2. Welcome 3. Recording 4. Didi

For example : Delay zone tone source as recording

Press[\*] for 3 seconds

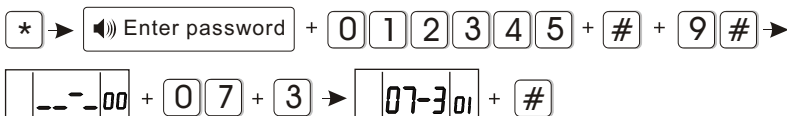

Hint: In disarm mode, once delay zone triggered and above 4 voices will be generated. press key 4 for 3 seconds and input the user password can be open and close it. When the tone source is recording mode, the voice phone will not play the recording.

### 6.9.8 Handshake tone input signal intensity ( default is 60)

For example: set it as 70

Press[\*] for 3 seconds

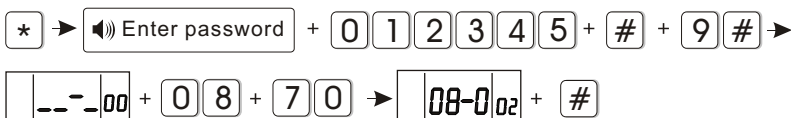

### 6.9.9 DTMF output signal intensity (The default is 04)

For example: set the DTMF output signal strength to 06

Press[\*] for 3 seconds

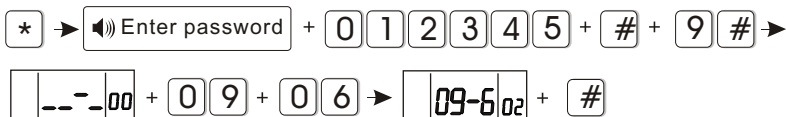

### 6.9.10 Set LCD standby brightness (default is 02)

For example: Set it as 22

Press[\*] for 3 seconds

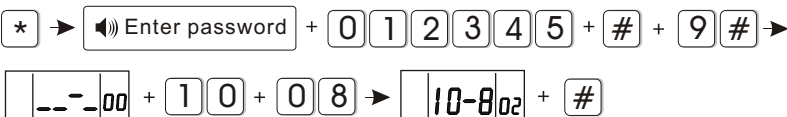

Brightness range: 0-10, Less than 2bits high zero

### 6.9.11 Alarm event retain time

When telephone line and GSM all fault, the alarm event will be retained in the preset time. Otherwise it will loss. After telephone line and GSM recovery, it will upload to the CMS. (default time is 10 mintus).

For example: set the alarm information retention time is 255 minutes

Press[\*] for 3 seconds

\* → Enter password + 0 1 2 3 4 5 + # + 9 # →

\_\_-\_\_00 + 1 1 + 2 5 5 → 11-503 + #

Retain time : 1-255 mintus. Less than 3 bits high zero.

## Chapter VII technical specification

### 7.1 General data

- 1.Power supply: 15V/2000mA
- 2.Built in rechargeable battery:11.1V/1000mah
- 3.System static current: <50mA(exclude wireless detector)
- 4.System alarming current: <300mA(exclude wireless high siren current)
- 5.System maximum output current:  $\leq$ 100mA(supply wireless detector)
- 6.Frequency:433MHz/868MHz
- 7.Signal transmit distance: 100 to 150 meters (open area)
- 8.The method of alarming dial: DTMF GSM or GPRS
- 9.Communication protocol with CMS: Ademco Contact ID
- 10.DTMF dial frequency variation: ,1.5%
- 11.Recording time:15s

### 7.2 Physical performance

Operation temperature range: 0°C-45°C(32F-120F)

Storage temperature range: -20°C-60°C(-4F-140F)

Relative humidity: 85% at 30°C(86F)

Color: as box indicated.

## Chapter VIII maintenance

### 8.1 Regular test

Design of components of the system is to reduce maintenance cost, but still it is suggested that periodical check may be carried out.

### 8.2 The cleanliness of control main machine

Main control panel may be stained by fingers or covered by dust after using for a while. Use soft cotton cloth or sponge to clean it, don't use any lubricant, liquid such as kerosene, acetone and strong gel which will damage appearance and the transparency of top window.

Attention: don't use any lubricant, liquid such as kerosene, acetone and strong gel which will damage appearance and the top transparency of window.

## Chapter VX limitation of the products

Although the products is a high standard products, there is also some limitation of them such as false alarm or no alarm. The reasons may be below:

Lack of maintenance, the system needs maintenance and test regularly test the sensitive of the detector may decrease and the siren may not whistle. Lack of power supply if no power input and the back up power is not enough, the panel can not work normally. Telephone line false, if the telephone line is cut, the panel could not send alarm signals. Limitation of smoke detectors, if the smoke is far from the smoke detector, the detector could not alarm. If the intrude break in through some door or window not monitored. Or someone know how to make the system not work.

